

comms
365

RUT240

Quick Start Guide v2.4

www.comms365.com / 01234 865880



Wiki knowledge base
<https://wiki.teltonika-networks.com/>



FRONT VIEW

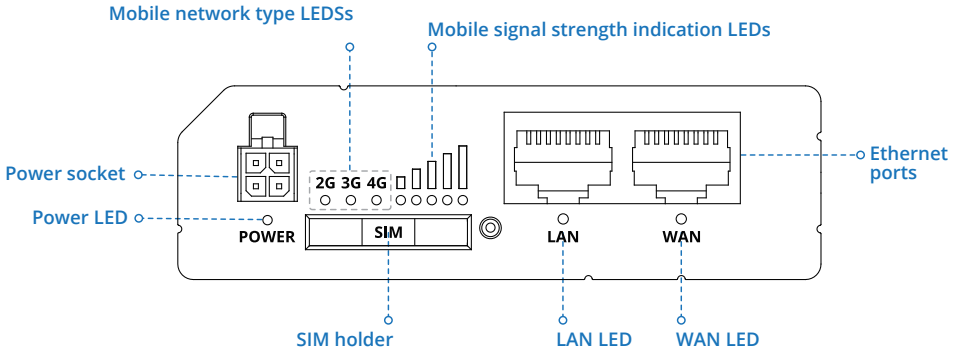

BACK VIEW

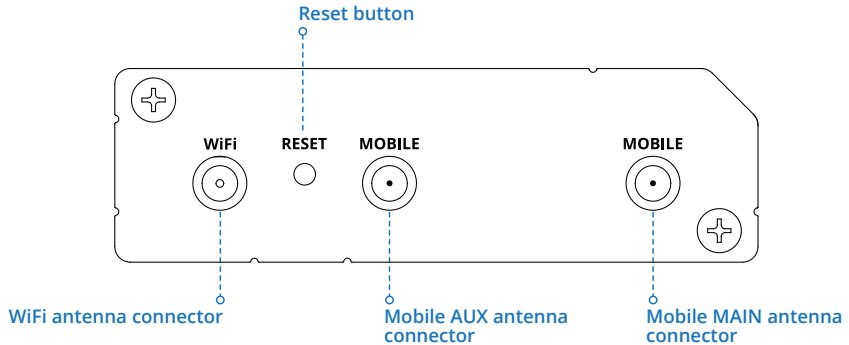

POWER SOCKET PINOUT

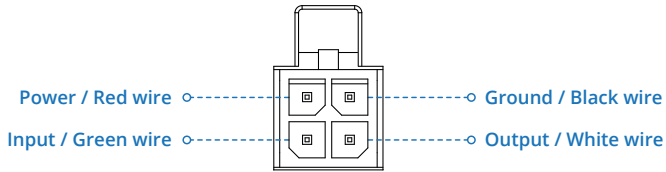

HARDWARE INSTALLATION

1. Push the SIM holder button with the SIM needle.
2. Pull out the SIM holder.
3. Insert your SIM card into the SIM holder.
4. Slide the SIM holder back into the router.
5. Attach all antennas.
6. Connect the power adapter to the socket on the front of the device. Then plug the other end of the power adapter into a power outlet.
7. Connect to the device wirelessly using SSID and password provided on the device information label or use an Ethernet cable connected to LAN port.

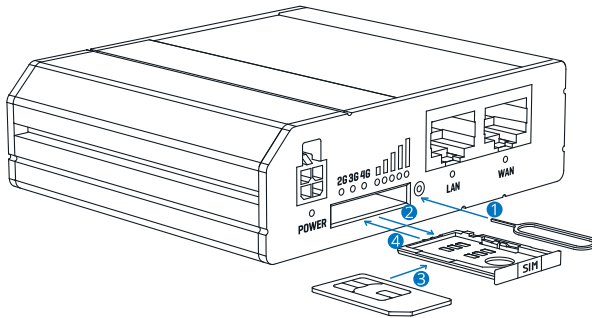

LOGIN TO DEVICE

1. To enter the router's Web interface (WebUI), type <http://192.168.1.1> into the URL field of your Internet browser.
2. Use login information shown in image A when prompted for authentication.
3. After you login, you will be prompted to change your password for security reasons. The new password must contain at least 8 characters, including at least one uppercase letter, one lowercase letter and one digit. This step is mandatory and **you will not be able to interact with the router's WebUI before you change the password.**
4. When you change the router's password, the **Configuration Wizard** will start. The **Configuration Wizard** is a tool used to setup some of the router's main operating parameters.
5. Go to the **Overview** page and pay attention to the **Signal Strength** indication (image B). To maximize the cellular performance try adjusting the antennas or changing the location of your device to achieve the best signal conditions.

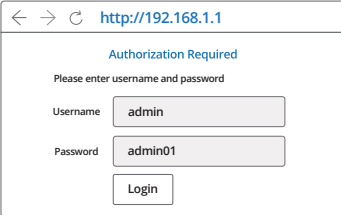
A. 

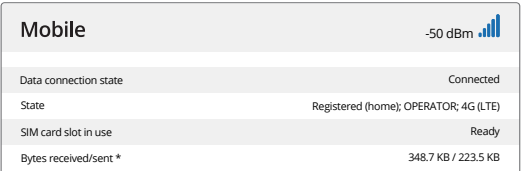
B. 

Mobile -50 dBm 	
Data connection state	Connected
State	Registered (home); OPERATOR: 4G (LTE)
SIM card slot in use	Ready
Bytes received/sent *	348.7 KB / 223.5 KB

TECHNICAL INFORMATION

Especificaciones de radio	
RF technologies	2G, 3G, 4G, WiFi
Max RF power	33 dBm@GSM, 24 dBm@WCDMA, 23 dBm@LTE, 20 dBm@ WiFi
Bundled accessories specifications*	
Power adapter	Input: 0.4 A@100-200 VAC, Output: 9 VDC, 1A, 4-pin plug
Mobile antenna	698-960/1710-2690 MHz, 50 Ω, VSWR<3, gain** 3 dBi, omnidirectional, SMA male connector
WiFi antenna	2400-2483,5 MHz, 50 Ω, VSWR<2, gain** 5 dBi, omnidirectional, RP-SMA male connector

*Order code dependent.

**Higher gain antenna can be connected to compensate for cable attenuation when a cable is used. The user is responsible for the compliance with the legal regulations.

SAFETY INFORMATION

RUT240 router must be used in compliance with any and all applicable national and international laws and with any special restrictions regulating the utilization of the communication module in prescribed applications and environments.

[BG] Bulgarian	С настоящето, TELTONIKA NETWORKS декларира, че RUT240 е в съответствие със съществените изисквания и другите приложения разпоредби на Директива 2014/53/EU.
[HR] Croatian	Ovim TELTONIKA NETWORKS izjavljuje da je ovaj RUT240 u skladu s bitnim zahtjevima i ostalim relevantnim odredbama Direktive 2014/53/EU.
[CZ] Czech	TELTONIKA NETWORKS tímto prohlašuje, že RUT240 splňuje základní požadavky a všechna příslušná ustanovení Směrnice 2014/53/EU.
[DK] Danish	Undertegnede TELTONIKA NETWORKS erklærer herved, at følgende udstyr RUT240 overholder de væsentlige krav og øvrige relevante krav i direktiv 2014/53/EU.
[NL] Dutch	Hierbij verklaart TELTONIKA NETWORKS dat het toestel I RUT240 in overeenstemming is met de essentiële eisen en de andere relevante bepalingen van richtlijn 2014/53/EU.
[EN] English	Hereby, TELTONIKA NETWORKS declares that this RUT240 is in compliance with the essential requirements and other relevant provisions of Directive 2014/53/EU.
[EE] Estonian	Käesolevaga kinnitab TELTONIKA NETWORKS seadme RUT240 vastavust direktiivi 2014/53/EU põhinõuetele ja nimetatud direktiivist tulenevatele teistele asjakohastele sätetele.
[FI] Finnish	TELTONIKA NETWORKS vakuuttaa täten että RUT240 tyyppinen laite on direktiivin 2014/53/EU oleellisten vaatimusten ja sitä koskevien direktiivin muiden ehtojen mukainen.
[FR] French	TELTONIKA NETWORKS déclare que cette RUT240 est conforme aux exigences essentielles et aux autres dispositions pertinentes de la directive 2014/53/EU.
[DE] German	Spoločnosť TELTONIKA NETWORKS týmto vyhlasuje, že smerovač RUT240 je v súlade so základnými požiadavkami a ďalšími príslušnými ustanoveniami smernice 2014/53/EU.
[GR] Greek	ΜΕ ΤΗΝ ΠΑΡΟΥΣΑ Ο ΚΑΤΑΣΚΕΥΑΣΤΗΣ ΤΗΛΤΟΝΙΚΑ ΝΕΤΟΥΡΚΣ ΔΗΛΩΝΕΙ ΟΤΙ ΡUT240 ΣΥΜΜΟΡΦΩΝΕΤΑΙ ΠΡΟΣ ΤΙΣ ΟΥΣΙΩΔΕΙΣ ΑΠΑΙΤΗΣΕΙΣ ΚΑΙ ΤΙΣ ΛΟΙΠΕΣ ΣΧΕΤΙΚΕΣ ΔΙΑΤΑΞΕΙΣ ΤΗΣ ΟΔΗΓΙΑΣ 2014/53/EU.
[HU] Hungarian	A TELTONIKA NETWORKS ezzenel klijentjenti, hogy a RUT240 típusú berendezés teljesíti az alapvető követelményeket és más 2014/53/EU irányelvben meghatározott vonatkozó rendelkezéseket.
[IE] Irish	Leis seo, dearbhaíonn TELTONIKA NETWORKS go gcomhlíonann an RUT240 seo bunriachtanais agus forálacha ábhartha eile Theoiric 2014/53/EU.
[IT] Italian	Con la presente, TELTONIKA NETWORKS dichiara che questo RUT240 è conforme ai requisiti essenziali e ad altre disposizioni pertinenti della Direttiva 2014/53/EU.
[LV] Latvian	Ar šo TELTONIKA NETWORKS deklarē, ka RUT240 atbilst Direktīvas 2014/53/EU būtiskajām prasībām un citiem ar to saistītajiem noteikumiem.
[LT] Lithuanian	Šiuo dokumentu UAB TELTONIKA NETWORKS deklaruoja, kad šis RUT240 atitinka esminius reikalavimus ir kitas 2014/53/EU Direktyvos nuostatas.
[MT] Maltese	Hawnhekk, TELTONIKA NETWORKS tidjikkjara li dan I-RUT240 huwa konformi mar-rekwiżiti essenzjali u dispozizzjonijiet rilevanti oħra tad-Direttiva 2014/53/EU.
[NO] Norwegian	TELTONIKA NETWORKS Erklærer herved at RUT240 er i samsvar med de grunnleggende krav og øvrige relevante krav i direktiv 2014/53/EU.
[PL] Polish	Niniejszym TELTONIKA NETWORKS deklaruje że RUT240 jest zgodny z zasadniczymi wymaganiami i innymi właściwymi postanowieniami Dyrektywy 2014/53/EU.
[PT] Portuguese	Eu, TELTONIKA NETWORKS declaro que o RUT240 cumpre os requisitos essenciais e outras provisões relevantes da Directiva 2014/53/EU.
[RO] Romanian	Prin prezenta, TELTONIKA NETWORKS declară că aparatul RUT240 este în conformitate cu cerințele esențiale și cu alte prevederi pertinente ale Directivei 2014/53/EU.
[SK] Slovak	Spoločnosť TELTONIKA NETWORKS týmto vyhlasuje, že smerovač RUT240 je v súlade so základnými požiadavkami a ďalšími príslušnými ustanoveniami smernice 2014/53/EU.
[SI] Slovenian	TELTONIKA NETWORKS izjavlja, da je ta RUT240 v skladu z bistvenimi zahtevami in drugimi relevantnimi določili direktive 2014/53/EU.
[ES] Spanish	Por la presente, TELTONIKA NETWORKS declara que este RUT240 cumple con los requisitos esenciales y otras exigencias relevantes de la Directiva 2014/53/EU.
[SE] Swedish	Härmed intygar TELTONIKA NETWORKS att denna RUT240 är i överensstämmelse med de väsentliga egenskapskrav och övriga relevanta bestämmelser som framgår av direktiv 2014/53/EU.

The full text of the EU declaration of conformity is available at the following Internet address: https://wiki.teltonika-networks.com/view/RUT240_CE/RED

[BG] Инструкция: Свържете адаптера на захранване, за да включите устройството. Отворете 192.168.1.1 в уеб браузър, за да настроите продукта.

Повече информация в <https://wiki.teltonika-networks.com/>

[HR] Upute za uporabu: Priključite napajanje. Otvorite 192.168.1.1 u svom internet pregledniku kako biste konfigurirali uređaj. Više informacija na <https://wiki.teltonika-networks.com>

[CZ] Návod k použití: Připojte napájecí adaptér k zapnutí přístroje. Otevřete 192.168.1.1 ve webovém prohlížeči pro konfiguraci produktu. Více informací najdete v <https://wiki.teltonika-networks.com/>

[DK] Instruktionsbog: Tilslut strømadapteren for at tænde for enheden. Åbn 192.168.1.1 i en webbrowser til at konfigurere produktet. Mere information i <https://wiki.teltonika-networks.com/>

[NL] Handleiding: Sluit voedingsadapter aan op het apparaat in te schakelen. Open 192.168.1.1 in een webbrowser om het product te configureren. Meer informatie in <https://wiki.teltonika-networks.com/>

[EN] Instruction Manual: Connect the power adapter to turn on the device. Open 192.168.1.1 in your web browser to configure it. More information on <https://wiki.teltonika-networks.com/>

[EE] Kasutusjuhend: Ühendage toiteadapter seadme sisselülitamiseks. Avatud 192.168.1.1 in veebilehitseja seadistada toodet. Rohkem teavet <https://wiki.teltonika-networks.com/>

[FI] Käyttöohje: Kytke virtalähde päälle laitteeseen. Avaa 192.168.1.1 selaimen määrittävä tuotteen. Lisää tietoa <https://wiki.teltonika-networks.com/>

[FR] Mode d'emploi: Connectez l'adaptateur d'alimentation pour allumer l'appareil. Ouvrez 192.168.1.1 dans un navigateur Web pour configurer le produit. Plus d'informations dans <https://wiki.teltonika-networks.com/>

[DE] Bedienungsanleitung: Verbinden Sie das Netzteil, um das Gerät einzuschalten. Öffnen Sie 192.168.1.1 in einem Web Browser, um das Produkt zu konfigurieren. Weitere Informationen im <https://wiki.teltonika-networks.com/>

[GR] εγχειρίδιο οδηγιών: Συνδέστε τον προσαρμογέα τροφοδοσίας για να ενεργοποιήσετε τη μονάδα. Ανοίξτε 192.168.1.1 σε ένα πρόγραμμα περιήγησης στο Web για να διαμορφώσετε το προϊόν. Περισσότερες πληροφορίες στο <https://wiki.teltonika-networks.com/>

[HU] Használati utasítás: Csatlakoztassa a hálózati adaptert a készülék bekapcsolásához. Megnyitása 192.168.1.1 egy webböngészőben beállítani a terméket. Több információt talál <https://wiki.teltonika-networks.com/>

[IL] Lámhleabhar Treoracha: Ceangail an t-adapter cumhachta chun an gléas a chasadh ar. Oscail 192.168.1.1 i do bhrabhsálaí gréasáin chun é a chumrú. Tuilleadh eolais ar <https://wiki.teltonika-networks.com/>

[IT] Manuale di istruzioni: collegare l'adattatore di alimentazione per accendere il dispositivo. Apri 192.168.1.1 nel tuo browser web per configurarlo. Maggiori informazioni su <https://wiki.teltonika-networks.com/>

[LV] Lietošanas instrukcija: Pievienojiet Strāvas adapteri, lai ieslēgtu ierīci. Atvērt 192.168.1.1 ar interneta pārlūku, lai konfigurētu produktu. Plašāka informācija <https://wiki.teltonika-networks.com/>

[LT] Naudojimosi instrukcija: Prijunkite maitinimo adapterį, įjunkite įrenginį. Interneto naršyklėje atidarykite adresą 192.168.1.1 - galite konfigūruoti gaminį. Daugiau informacijos rasite <https://wiki.teltonika-networks.com/>

[MT] Manwal tal-Istruzzjoni: Qabbad l-adapter tal-enerġija b'ix tiġhel l-apparat. Iftah 192.168.1.1 fil-web browser tiegħek b'ix tikkonfigurah. Aktar informazzjoni dwar <https://wiki.teltonika-networks.com/>

[NO] Bruksanvisningen: Koble strømadapteren for å slå på enheten. Åpne 192.168.1.1 i en netleser for å konfigurere produktet. Mer informasjon på <https://wiki.teltonika-networks.com/>

[PL] Instrukcja obsługi: Podłącz adapter zasilania, aby włączyć urządzenie. Otwórz 192.168.1.1 w przeglądarce internetowej, aby skonfigurować urządzenie. Więcej informacji w <https://wiki.teltonika-networks.com/>

[PT] Manual de instruções: Conecte o adaptador de alimentação para ligar o aparelho. Abra 192.168.1.1 em um navegador da web para configurar o produto. Mais informações em <https://wiki.teltonika-networks.com/>

[RO] Instrucțiunile de utilizare: Conectați adaptorul de alimentare pentru a porni aparatul. Deschide 192.168.1.1 într-un browser web pentru a configura produsul. Mai multe informații în <https://wiki.teltonika-networks.com/>

[SK] Návod na použitie: Pripojením napájacieho adaptéra zapnete zariadenie. Otvorte vo svojom webovom prehliadači stránku s IP adresou 192.168.1.1 a nakonfigurujte ho. Viac informácií na <https://wiki.teltonika-networks.com/>

[SI] Navodila: Priključite napajalnik za vklop naprave. Odprite 192.168.1.1 v spletnem brskalniku nastaviti izdelek. Več informacij v <https://wiki.teltonika-networks.com/>

[ES] Manual de instrucciones: Conecte el adaptador de alimentación para encender la unidad. Abra 192.168.1.1 en un navegador web para configurar el producto. Más información en <https://wiki.teltonika-networks.com/>

[SE] Instruktionsmanual: Anslut nätadap tern för att slå på enheten. Öppna 192.168.1.1 i en webbläsare för att konfigurera produkten. Mer information på <https://wiki.teltonika-networks.com/>



This sign means that all used electronic and electric equipment should not be mixed with general household waste.



This sign means that product meets the requirements of the applicable EU directives.